

Filters, Faucets, & Water Appliances

Section Contents

Duet Finishes - Accessory Faucets **67 - 68**

Little Gourmet® Hot Water Dispenser **69**

Mountain Chill® Water Chiller **70**

Safety Valve-Leak Detector **70**

Mountain Pure® Water Filtration **71 - 74**

Hot Water Faucets Overview **75**

Francis Anthony Collection **76 - 84**

Francis Anthony + Little Gourmet® **85 - 88**

Hot & Cold Water Faucets Overview **89**

Francis Anthony Collection **90 - 98**

Francis Anthony + Little Gourmet® **99 - 102**

Point-of-Use Drinking Faucets Overview **103**

Francis Anthony Collection **104 - 112**

Additional Collections **113 - 114**

Francis Anthony + Mountain Pure® **115 - 118**

Faucet Air Gaps **119**

Replacement Cartridges **119**

Fixture Planning Diagrams

Use the kitchen sink and bar/prep sink fixture planning diagram to simplify your product selection and complete your design.

Kitchen Sink Fixture Planning Diagram **24**

Bar/Prep Sink Fixture Planning Diagram **25**

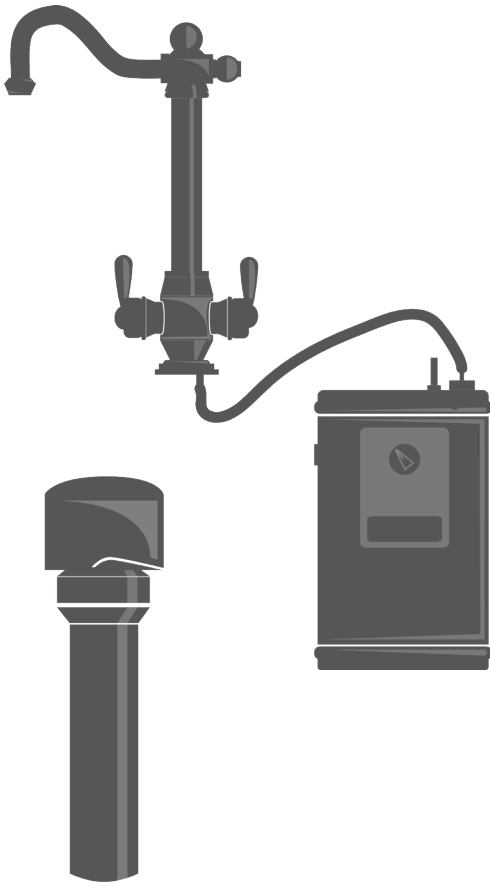



Accessory Faucet Duet Finishes

Mountain Plumbing's Duet Finish Collection highlights elements of your kitchen and bath design to give a truly balanced and unique look.

Available on the MT1820, MT1830, & MT1840 Series Accessory Faucets

Pages 77, 79, 81, 91, 93, 95, 105, 107, 109

Ordering Duet Products

All Duet products come with Matte Black as the base finish. To order please use the following three step instructions:

1. Find the Product You Want in a Duet Finish

2. Select Accent Finish & Use Model # Below to Order

Standard Model #	Product Name	Page	Brushed Nickel	Polished Chrome	Polished Nickel	Champagne Bronze
MT2000-2	Decorative Bottle Trap with Clean-Out Plug	236	MT2000-2D/BRN	MT2000-2D/CPB	MT2000-2D/PN	MT2000-2D/CHBRZ
MT5003L-NL	Lever Handle Angle Valve	156	MT5003L-NLD/BRN	MT5003L-NLD/CPB	MT5003L-NLD/PN	MT5003L-NLD/CHBRZ
MT300	Classic 3-1/2" Deluxe Stemball Kitchen Strainer	51	MT300D/BRN	MT300D/CPB	MT300D/PN	MT300D/CHBRZ
MT200EV	Complete Stopper & Strainer Unit Waste Disposer Trim	55	MT200EVD/BRN	MT200EVD/CPB	MT200EVD/PN	MT200EVD/CHBRZ
MT202	Extended Flange Stopper & Strainer Unit Waste Disposer Trim	55	MT202D/BRN	MT202D/CPB	MT202D/PN	MT202D/CHBRZ
MT957R	Round Deluxe Raised Air Switch with Freedom Mount	40	MT957RD/BRN	MT957RD/CPB	MT957RD/PN	MT957RD/CHBRZ
MT964K	Round Deluxe Knurled Raised Air Switch with Freedom Mount	42	MT964KD/BRN	MT964KD/CPB	MT964KD/PN	MT964KD/CHBRZ
MT1820-NL	Hot Water Faucet - Contemporary Round Body (120° Spout)	77	MT1820-NLD/PVDBRN	MT1820-NLD/CPB	MT1820-NLD/PVDPN	MT1820-NLD/CHBRZ
MT1830-NL	Hot Water Faucet - Contemporary Round Body (90° Spout)	79	MT1830-NLD/PVDBRN	MT1830-NLD/CPB	MT1830-NLD/PVDPN	MT1830-NLD/CHBRZ
MT1840-NL	Hot Water Faucet - Contemporary Round Body	81	MT1840-NLD/PVDBRN	MT1840-NLD/CPB	MT1840-NLD/PVDPN	MT1840-NLD/CHBRZ
MT1821-NL	Hot & Cold Faucet - Contemporary Round Body (120° Spout)	91	MT1821-NLD/PVDBRN	MT1821-NLD/CPB	MT1821-NLD/PVDPN	MT1821-NLD/CHBRZ
MT1831-NL	Hot & Cold Faucet - Contemporary Round Body (90° Spout)	93	MT1831-NLD/PVDBRN	MT1831-NLD/CPB	MT1831-NLD/PVDPN	MT1831-NLD/CHBRZ
MT1841-NL	Hot & Cold Faucet - Contemporary Round Body	95	MT1841-NLD/PVDBRN	MT1841-NLD/CPB	MT1841-NLD/PVDPN	MT1841-NLD/CHBRZ
MT1823-NL	Point-of-Use Faucet - Contemporary Round Body (120° Spout)	105	MT1823-NLD/PVDBRN	MT1823-NLD/CPB	MT1823-NLD/PVDPN	MT1823-NLD/CHBRZ
MT1833-NL	Point-of-Use Faucet - Contemporary Round Body (90° Spout)	107	MT1833-NLD/PVDBRN	MT1833-NLD/CPB	MT1833-NLD/PVDPN	MT1833-NLD/CHBRZ
MT1843-NL	Point-of-Use Faucet - Contemporary Round Body	109	MT1843-NLD/PVDBRN	MT1843-NLD/CPB	MT1843-NLD/PVDPN	MT1843-NLD/CHBRZ
Products with Knurling						
MT1820-NL	Hot Water Faucet - Contemporary Round Body (120° Spout)	77	MT1820-NLDK/PVDBRN	MT1820-NLDK/CPB	MT1820-NLDK/PVDPN	MT1820-NLDK/CHBRZ
MT1830-NL	Hot Water Faucet - Contemporary Round Body (90° Spout)	79	MT1830-NLDK/PVDBRN	MT1830-NLDK/CPB	MT1830-NLDK/PVDPN	MT1830-NLDK/CHBRZ
MT1840-NL	Hot Water Faucet - Contemporary Round Body	81	MT1840-NLDK/PVDBRN	MT1840-NLDK/CPB	MT1840-NLDK/PVDPN	MT1840-NLDK/CHBRZ
MT1821-NL	Hot & Cold Faucet - Contemporary Round Body (120° Spout)	91	MT1821-NLDK/PVDBRN	MT1821-NLDK/CPB	MT1821-NLDK/PVDPN	MT1821-NLDK/CHBRZ
MT1831-NL	Hot & Cold Faucet - Contemporary Round Body (90° Spout)	93	MT1831-NLDK/PVDBRN	MT1831-NLDK/CPB	MT1831-NLDK/PVDPN	MT1831-NLDK/CHBRZ
MT1841-NL	Hot & Cold Faucet - Contemporary Round Body	95	MT1841-NLDK/PVDBRN	MT1841-NLDK/CPB	MT1841-NLDK/PVDPN	MT1841-NLDK/CHBRZ
MT1823-NL	Point-of-Use Faucet - Contemporary Round Body (120° Spout)	105	MT1823-NLDK/PVDBRN	MT1823-NLDK/CPB	MT1823-NLDK/PVDPN	MT1823-NLDK/CHBRZ
MT1833-NL	Point-of-Use Faucet - Contemporary Round Body (90° Spout)	107	MT1833-NLDK/PVDBRN	MT1833-NLDK/CPB	MT1833-NLDK/PVDPN	MT1833-NLDK/CHBRZ
MT1843-NL	Point-of-Use Faucet - Contemporary Round Body	109	MT1843-NLDK/PVDBRN	MT1843-NLDK/CPB	MT1843-NLDK/PVDPN	MT1843-NLDK/CHBRZ

3a. Brushed Nickel - Find Prices & Order

Brushed Nickel	Price
MT2000-2D/BRN	\$ 627
MT5003L-NLD/BRN	\$ 284
MT300D/BRN	\$ 188
MT200EVD/BRN	\$ 192
MT202D/BRN	\$ 205
MT957RD/BRN	\$ 384
MT964KD/BRN	\$ 384
MT1820-NLD/PVDBRN	\$ 970
MT1830-NLD/PVDBRN	\$ 929
MT1840-NLD/PVDBRN	\$ 929
MT1821-NLD/PVDBRN	\$ 1229
MT1831-NLD/PVDBRN	\$ 1189
MT1841-NLD/PVDBRN	\$ 1189
MT1823-NLD/PVDBRN	\$ 756
MT1833-NLD/PVDBRN	\$ 737
MT1843-NLD/PVDBRN	\$ 737
Products with Knurling	
MT1820-NLDK/PVDBRN	\$ 1047
MT1830-NLDK/PVDBRN	\$ 1007
MT1840-NLDK/PVDBRN	\$ 1007
MT1821-NLDK/PVDBRN	\$ 1341
MT1831-NLDK/PVDBRN	\$ 1302
MT1841-NLDK/PVDBRN	\$ 1302
MT1823-NLDK/PVDBRN	\$ 816
MT1833-NLDK/PVDBRN	\$ 813
MT1843-NLDK/PVDBRN	\$ 813

3b. Polished Chrome - Find Prices & Order

Brushed Nickel	Price
MT2000-2D/CPB	\$ 627
MT5003L-NLD/CPB	\$ 284
MT300D/CPB	\$ 188
MT200EVD/CPB	\$ 192
MT202D/CPB	\$ 205
MT957RD/CPB	\$ 384
MT964KD/CPB	\$ 384
MT1820-NLD/CPB	\$ 970
MT1830-NLD/CPB	\$ 929
MT1840-NLD/CPB	\$ 929
MT1821-NLD/CPB	\$ 1229
MT1831-NLD/CPB	\$ 1189
MT1841-NLD/CPB	\$ 1189
MT1823-NLD/CPB	\$ 756
MT1833-NLD/CPB	\$ 737
MT1843-NLD/CPB	\$ 737
Products with Knurling	
MT1820-NLDK/CPB	\$ 1047
MT1830-NLDK/CPB	\$ 1007
MT1840-NLDK/CPB	\$ 1007
MT1821-NLDK/CPB	\$ 1341
MT1831-NLDK/CPB	\$ 1302
MT1841-NLDK/CPB	\$ 1302
MT1823-NLDK/CPB	\$ 816
MT1833-NLDK/CPB	\$ 813
MT1843-NLDK/CPB	\$ 813

3c. Polished Nickel - Find Prices & Order

Brushed Nickel	Price
MT2000-2D/PN	\$ 627
MT5003L-NLD/PN	\$ 284
MT300D/PN	\$ 188
MT200EVD/PN	\$ 192
MT202D/PN	\$ 205
MT957RD/PN	\$ 384
MT964KDS/PN	\$ 384
MT1820-NLD/PVDPN	\$ 970
MT1830-NLD/PVDPN	\$ 929
MT1840-NLD/PVDPN	\$ 929
MT1821-NLD/PVDPN	\$ 1229
MT1831-NLD/PVDPN	\$ 1189
MT1841-NLD/PVDPN	\$ 1189
MT1823-NLD/PVDPN	\$ 756
MT1833-NLD/PVDPN	\$ 737
MT1843-NLD/PVDPN	\$ 737
Products with Knurling	
MT1820-NLDK/PVDPN	\$ 1047
MT1830-NLDK/PVDPN	\$ 1007
MT1840-NLDK/PVDPN	\$ 1007
MT1821-NLDK/PVDPN	\$ 1341
MT1831-NLDK/PVDPN	\$ 1302
MT1841-NLDK/PVDPN	\$ 1302
MT1823-NLDK/PVDPN	\$ 816
MT1833-NLDK/PVDPN	\$ 813
MT1843-NLDK/PVDPN	\$ 813

3d. Champagne Bronze - Find Prices & Order

Brushed Nickel	Price
MT2000-2D/CHBRZ	\$ 627
MT5003L-NLD/CHBRZ	\$ 284
MT300D/CHBRZ	\$ 188
MT200EVD/CHBRZ	\$ 192
MT202D/CHBRZ	\$ 205
MT957RD/CHBRZ	\$ 384
MT964KD/CPB	\$ 384
MT1820-NLD/CHBRZ	\$ 970
MT1830-NLD/CHBRZ	\$ 929
MT1840-NLD/CHBRZ	\$ 929
MT1821-NLD/CHBRZ	\$ 1229
MT1831-NLD/CHBRZ	\$ 1189
MT1841-NLD/CHBRZ	\$ 1189
MT1823-NLD/CHBRZ	\$ 756
MT1833-NLD/CHBRZ	\$ 737
MT1843-NLD/CHBRZ	\$ 737
Products with Knurling	
MT1820-NLDK/CHBRZ	\$ 1047
MT1830-NLDK/CHBRZ	\$ 1007
MT1840-NLDK/CHBRZ	\$ 1007
MT1821-NLDK/CHBRZ	\$ 1341
MT1831-NLDK/CHBRZ	\$ 1302
MT1841-NLDK/CHBRZ	\$ 1302
MT1823-NLDK/CHBRZ	\$ 816
MT1833-NLDK/CHBRZ	\$ 813
MT1843-NLDK/CHBRZ	\$ 813



MT641-3 \$724

- Indicator Light
- Stainless Steel Housing
- Sensor Prevents Dry Start-Up
- Provides 190 °F Water Instantly
- 7 3/4" Wide x 12" High x 8" Deep



Scan the QR Code to Watch Our Little Gourmet Installation Video



Highly recommended to use the MT1250XL water filtration system which incorporates an anti-scaling media to prolong the life of the hot tank.

- **MT1250XL = \$473**
- **Refer to page 71**

Little Gourmet

Premium Hot Water Dispenser

Reverse Osmosis Compatible:
Includes Stainless Steel Inlet, Stainless Steel Heating Coil, and Stainless Steel Tank

1300w Power
Compared to 750w for Insinkerator

Energy Efficient
Uses Less Energy than a 40w Light Bulb

2.5 Quart Tank Size
Equivalent to 5/8 Gallon

3 Year Warranty
Extended 4 Year Warranty when paired with any Mountain Pure® Filter

So Many Uses:

Boil Water Faster
Starting off with Little Gourmet hot water will lead to quicker boiling water

Instant Water for Tea & Coffee
Quickly and easily make the perfect cup

Clean Stubborn Stuck-on Messes
Difficult to clean dishes and utensils become easy with the cleaning power of instant hot water at your fingertips

Warm Baby Food and Bottles
Little Gourmet hot water can quickly and safely warm baby food and bottles

Loosen Jar Lids
Place the top of a jar briefly under the Little Gourmet to aid in removing difficult to open jar lids

First Aid
Use Little Gourmet hot water to create a hot compress for quick pain relief

Remove Labels from Bottles
A quick run under Little Gourmet hot water will remove labels and residue

Remove Wax
Instant hot water from the Little Gourmet is perfect for removing wax from candle holders

Melt Chocolate
Quickly create a double boiler with the Little Gourmet hot water to melt chocolate to perfection

Warm Cooking Utensils
Use the Little Gourmet to warm beaters for creaming butter, a knife for cutting cheeses, or for ice cream scoops

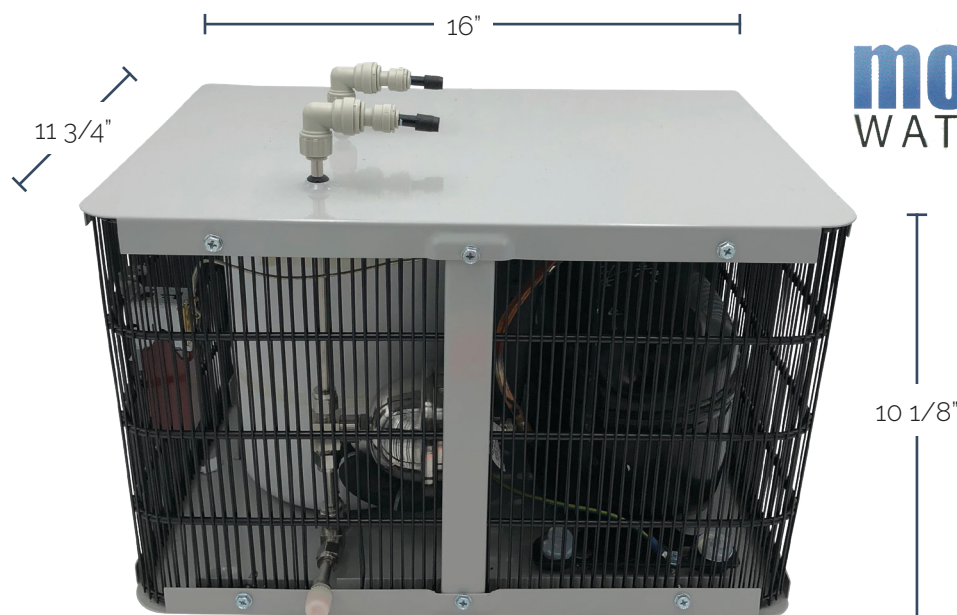

mountain chill[®]
WATER CHILLER

MT670-2 

\$1,899

Have you ever wondered what it would be like to have ice cold water anytime you want without having to wait for it to cool down? An instantly perfect cup of lemonade or ice tea made with the Mountain Chill® Water Chiller is the refreshing way to cool down on a hot summer day. Mountain Chill® hides cleanly and simply beneath the sink and provides 1.5 gallons (per hour) of crisp, cool water from your own faucet.

Having the Mountain Chill® Water Chiller in your home is the ultimate in convenience. When paired with the Mountain Pure® Filtration System, clean, pure water can be yours to enjoy anytime day or night.

Features:

- Cools your water to between 41° to 50°
- Large 1/2 Gallon Stainless Steel Storage Tank
- Chills up to 3 Gallons Per Hour
- Lead Free
- Attaches to Accessory Faucet
- 16" Wide x 10-1/8" High x 11-3/4" Deep
- 3 Year Compressor Warranty
- C-UL-US, CE, CB Certification

Safety Valve-Leak Detector

MT6LD **\$ 198**

A flood often happens without warning causing substantial flooding and severe property damage if undetected. Mountain Plumbing's safety valve-leak detector automatically shuts off the water source and sounds off an audible alarm (similar to a smoke detector) when moisture is detected.

- Automatically shuts off once water is detected
- Audio alarm when leak occurs
- Operates on 9V battery
- Quick connect 1/4" adaptor included for easy installations
- Use with Mountain Plumbing Little Gourmet® hot tank and/or Mountain Pure® filtration unit



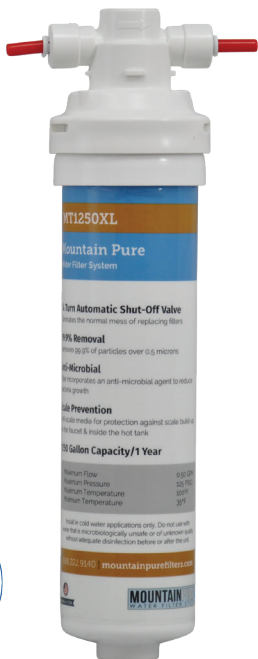

12 1/2"



Mountain Pure® Point-of-Use Carbon Filtration System

MT1250XL

The pinnacle of convenience and satisfaction, Mountain Pure® brings fresh, pristine water to you directly through your own faucets. Access to clean water is of the utmost importance in everyday life, and having the freshest, best tasting water available anytime can save you both time and money. Just think how much you spend on bottled water from week to week - savings and ease can be found when you have your own filtration system. Mountain Pure® allows you to enjoy clean, safe water for drinking, cooking, and even face washing when you install in your bathroom.

Mountain Pure® Carbon Filtration System comes with carbon filter cartridge that incorporates powder activated carbon and a bacteriostatic agent that protects it from bacteria growth. 1/4 Turn automatic shut-off valve, allows for easy replacement and eliminates the usual mess of replacing filters. Includes MT1250XL/RFC Filter.

Mountain Pure® Filter Features:

- More efficient and clog resistant - unique filter media created by attaching powdered activated carbon and lead absorbent material onto a cellulose-free synthetic fiber matrix
- Filter removes 99.9% of particles over .5 microns
- Filter incorporates an anti-microbial agent to reduce bacteria
- Anti-scale media for protection against scale build-up on the faucet and inside of the hot tank
- 1250 gallon capacity - lasts 1 year based on average usage
- Operates without wasting water like R.O. filters



MT1250XL \$ 473

Impurities Removed:
Prevents Scale
Chlorine
Bad Tastes/Odors
Chloramines
Dirt and Rust
Giardia Lambia Cysts
Cryptosporidium Cysts
Molds and Algae
Asbestos Fibers
99.9% of all particles .5 Micron or larger
Lead
Trihalomethanes
Volatile Organic Chemicals
Removes Turbidity
Removes Pathogenic Bacteria
Leaves Essential Minerals Intact
Self Sterilizing
Leaves Natural Minerals such as Calcium, Magnesium, & Potassium
Automatic Shut-Off when Replacing the Cartridge

Mountain Pure® Replacement Cartridge (Fits Model MT1250XL)

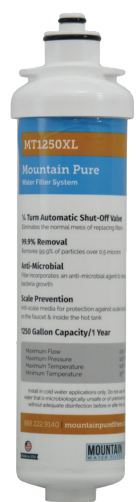

MT1250XL/RFC \$ 205

- Carbon replacement cartridge for MT1250XL water filtration system
- Filter Capacity = 1250 gallons
- Cartridges should be replaced once a year



Scan the QR Code to Watch Our Filter Installation Video



Mountain Pure® 3,000 Gallon Full Flow Filter System

MT3K-HF \$559



Mountain Pure® Filter Features:

- 3,000 Gallon Capacity
- No additional faucet required
- Built-in water shut-off valve allows for easier cartridge changes
- Commercial grade plastic canister protects the filter system from splitting or bursting
- Reduces particles as small as 0.5 micron in size by mechanical means
- Retains vital minerals found naturally in water to ensure the health and delicious taste of your water



13 1/2"

Impurities Removed (3K & 6K):

Lead
Sediment
VOC
Pesticides
Hydrogen Sulfide
Aluminum Chlorine
Algae
Turbidity
Pathogenic Cysts
Foul Odors & Tastes
Iron
Molds
Trihalomethanes
Asbestos Fibers
Rust
Suspended Solids
Sub-micron Asbestos
MTBE



Mountain Pure® Replacement Cartridge (Fits Model MT3K-HF)

MT3K-HF/RFC \$ 218

- Carbon replacement cartridge for MT3K-HF water filtration system
- Filter Capacity = 3000 gallons
- Cartridges should be replaced once a year



Mountain Pure® 6,000 Gallon Full Flow Filter System

MT6K-HF \$584

Mountain Pure® Filter Features:

- 6,000 Gallon Capacity
- No additional faucet required
- Built-in water shut-off valve allows for easier cartridge changes
- Commercial grade plastic canister protects the filter system from splitting or bursting
- Reduces particles as small as 0.5 micron in size by mechanical means
- Retains vital minerals found naturally in water to ensure the health and delicious taste of your water



18 1/2"



Mountain Pure® Replacement Cartridge (Fits Model MT6K-HF)

MT6K-HF/RFC \$ 244

- Carbon replacement cartridge for MT6K-HF water filtration system
- Filter Capacity = 6000 gallons
- Cartridges should be replaced once a year



Mountain Pure® Ceramic Water Filtration System - Plastic Canister

MT660 \$ 687

Mountain Pure® Ceramic Filtration System comes with ceramic filter cartridge. Includes MT661/RFC Filter

Mountain Pure® Filter Features:

- Filter removes 99.9% of particles over .5 microns
- 1000 gallon capacity - lasts 9 months based on average usage
- Operates without wasting water like R.O. filters
- The cleanable filter element makes for easy maintenance



Mountain Pure® Ceramic Water Filtration System - Stainless Steel Canister

MT662-2 \$ 735

- Same as MT660 except housing is 304 Stainless Steel



Mountain Pure® Replacement Cartridge (Fits Models MT660 & MT662-2)

MT661/RFC \$ 255

- Ceramic replacement cartridge for MT660 and MT662-2 water filtration systems
- Filter Capacity = 1000 gallons
- Cartridges should be replaced every 9 months or with diminished water flow

Notes:



Say Goodbye to Household Lead in **Your Water.**



Household Lead: The Facts

Lead in drinking water accounts for **10-20%** of human exposure. Major sources of lead in your drinking water can be found in your home's plumbing system.

Lead can leach into your water from pipes, solder, and faucets.



High Blood Pressure

Lead can increase the risk of high blood pressure.



Kidney Damage

Lead can increase the risk of kidney damage.



Bone Damage

Lead can increase the risk of bone damage.



Risk to Pregnant Mothers

Lead can be a potentially fatal risk to pregnant mothers.

Homes built prior to 1986 may have 20% or more lead in their plumbing system.

Lead can be found in newer homes as well. Until June 2014, the legal limit for "lead-free" pipes was up to 8%.











Source: United States Environmental Protection Agency (EPA)



Our **MT1250XL** and **MT3K-HF Filters** are independently tested and certified by NSF International against NSF/ANSI Standard 42 and 53 for the reduction of chlorine (Standard No. 42) and lead (Standard No. 53).

Our **MT6K-HF Filter's** Chlorine & Lead reduction capacities are based on laboratory testing conducted using test protocols contained in NSF standards 42 and 53 respectfully.

Hot Water Faucets Table of Contents

Image	Model Number	Duet Finishes	Knurling	Industrial Handle	Page
	MT1800-NL	NO	NO	NO	76
	MT1820-NL	YES	YES	NO	77
	MT1820-NLIH	NO	NO	YES	78
	MT1830-NL	YES	YES	NO	79
	MT1830-NLIH	NO	NO	YES	80
	MT1840-NL	YES	YES	NO	81
	MT1840-NLIH	NO	NO	YES	82
	MT1850-NL	NO	NO	NO	83
	MT1870-NL	NO	NO	NO	83
	MT1880-NL	NO	NO	NO	84

For Hot Tank

Francis Anthony Collection
76 - 84

Francis Anthony + Little
Gourmet® Packages
85 - 88

For Filters, Chiller, & Hot Tank

Francis Anthony Collection
90 - 98

Francis Anthony + Little
Gourmet® Packages
99 - 102

For Filters & Chiller

Francis Anthony Collection
104 - 112

Additional Collections
113 - 114

Francis Anthony + Mountain
Pure® Filter Packages
115 - 118

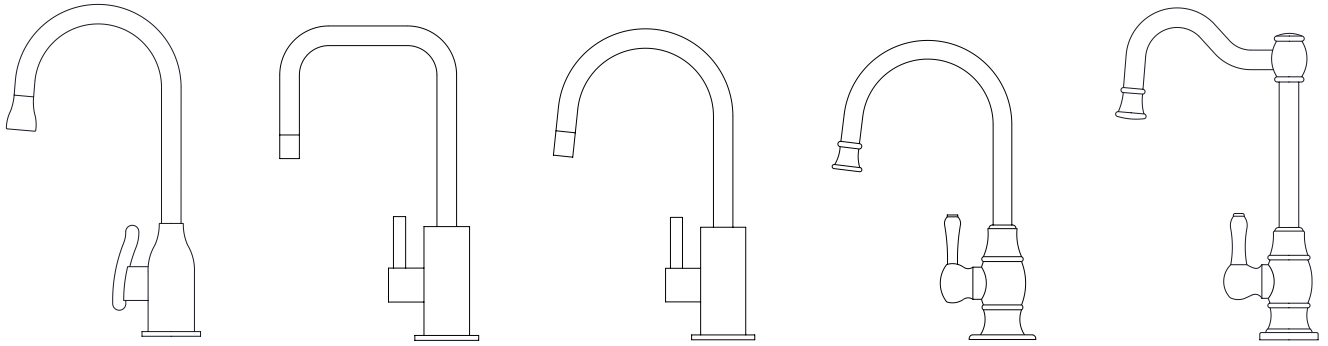

Francis Anthony Collection



MT1800-NL



Francis Anthony Collection

Hot Water Faucet with Modern Curved Body & Handle

MT1800-NL

- These Lead Free faucets are only compatible with the Little Gourmet® heating tank (MT641-3)
- 1/4 Turn Ceramic Cartridge
- 1-3/16" minimum to 1-3/8" maximum mounting hole required
- Heating tank is not included
- This hot water faucet is ICC listed
- Reverse Osmosis Safe
- NSF/ANSI/CAN 61: Q ≤ 1

Standard Finishes

MT1800-NL/CHBRZ	Champagne Bronze	\$ 1013
MT1800-NL/CPB	Polished Chrome	\$ 511
MT1800-NL/MB	Matte Black	\$ 861
MT1800-NL/ORB	Oil Rubbed Bronze	\$ 770
MT1800-NL/PVDBRN	PVD Brushed Nickel	\$ 565
MT1800-NL/PVDPN	PVD Polished Nickel	\$ 565
MT1800-NL/VB	Venetian Bronze	\$ 770

Group 1 Finishes

All Group 1 Finishes **\$ 861**

Group 2 Finishes

All Group 2 Finishes **\$ 1013**

Hot Water Faucet with Contemporary Round Body & Handle (120° Spout)

MT1820-NL

- These Lead Free faucets are only compatible with the Little Gourmet® heating tank (MT641-3)
- 1/4 Turn Ceramic Cartridge
- 1-3/16" minimum to 1-3/8" maximum mounting hole required
- Heating tank is not included
- This hot water faucet is ICC listed
- Reverse Osmosis Safe
- NSF/ANSI/CAN 61: Q ≤ 1



Francis Anthony Collection

MT1820-NL

Standard Finishes

MT1820-NL/BRS	Brushed Stainless	\$ 902
MT1820-NL/CHBRZ	Champagne Bronze	\$ 1062
MT1820-NL/CPB	Polished Chrome	\$ 535
MT1820-NL/MB	Matte Black	\$ 902
MT1820-NL/ORB	Oil Rubbed Bronze	\$ 806
MT1820-NL/PVDBRN	PVD Brushed Nickel	\$ 591
MT1820-NL/PVDPN	PVD Polished Nickel	\$ 591
MT1820-NL/ULB	Unlacquered Brass	\$ 535
MT1820-NL/VB	Venetian Bronze	\$ 806

Group 1 Finishes

All Group 1 Finishes	\$ 902
----------------------	--------

Group 2 Finishes

All Group 2 Finishes	\$ 1062
----------------------	---------

Duet Finishes

(Matte Black is the Base Color for All Duet Products)

MT1820-NLD/PVDBRN	Brushed Nickel	\$ 970
MT1820-NLD/CHBRZ	Champagne Bronze	\$ 970
MT1820-NLD/CPB	Polished Chrome	\$ 970
MT1820-NLD/PVDPN	Polished Nickel	\$ 970

Knurled Duet Finishes

(Matte Black is the Base Color for All Duet Products)

MT1820-NLDK/PVDBRN	Brushed Nickel	\$ 1047
MT1820-NLDK/CHBRZ	Champagne Bronze	\$ 1047
MT1820-NLDK/CPB	Polished Chrome	\$ 1047
MT1820-NLDK/PVDPN	Polished Nickel	\$ 1047

Knurled Accent Only

(Knurling Added to Handle and Faucet Tip)

MT1820-NLK/PVDBRN	Brushed Nickel	\$ 1047
MT1820-NLK/CHBRZ	Champagne Bronze	\$ 1047
MT1820-NLK/CPB	Polished Chrome	\$ 1047
MT1820-NLK/PVDPN	Polished Nickel	\$ 1047

MT1820 Duet Finish Combinations



Base:
Matte Black (MB)
Accent:
Brushed Nickel (BRN)



Base:
Matte Black (MB)
Accent:
Polished Chrome (CPB)



Base:
Matte Black (MB)
Accent:
Polished Nickel (PN)



Base:
Matte Black (MB)
Accent:
Champagne Bronze (CHBRZ)

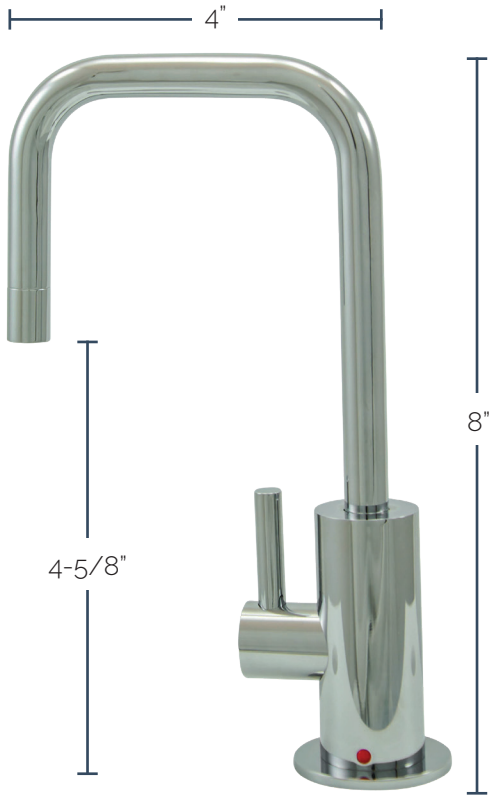

MT1830-NL

Duet

Knurled



Francis Anthony
collection

Hot Water Faucet with Contemporary Round Body & Handle (90° Spout)

MT1830-NL

- These Lead Free faucets are only compatible with the Little Gourmet® heating tank (MT641-3)
- 1/4 Turn Ceramic Cartridge
- 1-3/16" minimum to 1-3/8" maximum mounting hole required
- Heating tank is not included
- This hot water faucet is ICC listed
- Reverse Osmosis Safe
- NSF/ANSI/CAN 61: Q ≤ 1

Standard Finishes

MT1830-NL/BRS	Brushed Stainless	\$ 861
MT1830-NL/CHBRZ	Champagne Bronze	\$ 1013
MT1830-NL/CPB	Polished Chrome	\$ 511
MT1830-NL/MB	Matte Black	\$ 861
MT1830-NL/ORB	Oil Rubbed Bronze	\$ 770
MT1830-NL/PVDBRN	PVD Brushed Nickel	\$ 565
MT1830-NL/PVDPN	PVD Polished Nickel	\$ 565
MT1830-NL/ULB	Unlacquered Brass	\$ 511
MT1830-NL/VB	Venetian Bronze	\$ 770

Group 1 Finishes

All Group 1 Finishes	\$ 861
----------------------	---------------

Group 2 Finishes

All Group 2 Finishes	\$ 1013
----------------------	----------------

Duet Finishes

(Matte Black is the Base Color for All Duet Products)

MT1830-NLD/PVDBRN	Brushed Nickel	\$ 929
MT1830-NLD/CHBRZ	Champagne Bronze	\$ 929
MT1830-NLD/CPB	Polished Chrome	\$ 929
MT1830-NLD/PVDPN	Polished Nickel	\$ 929

Knurled Duet Finishes

(Matte Black is the Base Color for All Duet Products)

MT1830-NLDK/PVDBRN	Brushed Nickel	\$ 1007
MT1830-NLDK/CHBRZ	Champagne Bronze	\$ 1007
MT1830-NLDK/CPB	Polished Chrome	\$ 1007
MT1830-NLDK/PVDPN	Polished Nickel	\$ 1007

Knurled Accent Only

(Knurling Added to Handle and Faucet Tip)

MT1830-NLK/PVDBRN	Brushed Nickel	\$ 1007
MT1830-NLK/CHBRZ	Champagne Bronze	\$ 1007
MT1830-NLK/CPB	Polished Chrome	\$ 1007
MT1830-NLK/PVDPN	Polished Nickel	\$ 1007

MT1830 Duet Finish Combinations



Base:
Matte Black (MB)

Accent:
Brushed Nickel (BRN)



Base:
Matte Black (MB)

Accent:
Polished Chrome (CPB)



Base:
Matte Black (MB)

Accent:
Polished Nickel (PN)



Base:
Matte Black (MB)

Accent:
Champagne Bronze (CHBRZ)

Hot Water Faucet with Contemporary Round Body & Handle



MT1840-NL

Duet

Knurled



Francis Anthony Collection

MT1840-NL

- These Lead Free faucets are only compatible with the Little Gourmet® heating tank (MT641-3)
- 1/4 Turn Ceramic Cartridge
- 1-3/16" minimum to 1-3/8" maximum mounting hole required
- Heating tank is not included
- This hot water faucet is ICC listed
- Reverse Osmosis Safe
- NSF/ANSI/CAN 61: Q ≤ 1

* **MT1840/SS Replaces Discontinued MT1400/SS**

Standard Finishes

MT1840/SS	Stainless Steel	\$ 528
MT1840-NL/CHBRZ	Champagne Bronze	\$ 1013
MT1840-NL/CPB	Polished Chrome	\$ 511
MT1840-NL/MB	Matte Black	\$ 861
MT1840-NL/ORB	Oil Rubbed Bronze	\$ 770
MT1840-NL/PVDBRN	PVD Brushed Nickel	\$ 565
MT1840-NL/PVDPN	PVD Polished Nickel	\$ 565
MT1840-NL/ULB	Unlacquered Brass	\$ 511
MT1840-NL/VB	Venetian Bronze	\$ 770

Group 1 Finishes

All Group 1 Finishes	\$ 861
----------------------	---------------

Group 2 Finishes

All Group 2 Finishes	\$ 1013
----------------------	----------------

Duet Finishes

(Matte Black is the Base Color for All Duet Products)

MT1840-NLD/PVDBRN	Brushed Nickel	\$ 929
MT1840-NLD/CHBRZ	Champagne Bronze	\$ 929
MT1840-NLD/CPB	Polished Chrome	\$ 929
MT1840-NLD/PVDPN	Polished Nickel	\$ 929

Knurled Duet Finishes

(Matte Black is the Base Color for All Duet Products)

MT1840-NLDK/PVDBRN	Brushed Nickel	\$ 1007
MT1840-NLDK/CHBRZ	Champagne Bronze	\$ 1007
MT1840-NLDK/CPB	Polished Chrome	\$ 1007
MT1840-NLDK/PVDPN	Polished Nickel	\$ 1007

Knurled Accent Only

(Knurling Added to Handle and Faucet Tip)

MT1840-NLK/PVDBRN	Brushed Nickel	\$ 1007
MT1840-NLK/CHBRZ	Champagne Bronze	\$ 1007
MT1840-NLK/CPB	Polished Chrome	\$ 1007
MT1840-NLK/PVDPN	Polished Nickel	\$ 1007

MT1840 Duet Finish Combinations



Base:
Matte Black (MB)

Accent:
Brushed Nickel (BRN)



Base:
Matte Black (MB)

Accent:
Polished Chrome (CPB)



Base:
Matte Black (MB)

Accent:
Polished Nickel (PN)



Base:
Matte Black (MB)

Accent:
Champagne Bronze (CHBRZ)



MT1850-NL

Francis Anthony
Collection



MT1870-NL

Francis Anthony
Collection

Hot Water Faucet with Traditional Curved Body & Curved Handle

MT1850-NL

- These Lead Free faucets are only compatible with the Little Gourmet® heating tank (MT641-3)
- 1/4 Turn Ceramic Cartridge
- 1-3/16" minimum to 1-3/8" maximum mounting hole required
- Heating tank is not included
- This hot water faucet is ICC listed
- Reverse Osmosis Safe
- NSF/ANSI/CAN 61: Q ≤ 1

Standard Finishes

MT1850-NL/BRS	Brushed Stainless	\$ 861
MT1850-NL/CHBRZ	Champagne Bronze	\$ 1013
MT1850-NL/CPB	Polished Chrome	\$ 511
MT1850-NL/MB	Matte Black	\$ 861
MT1850-NL/ORB	Oil Rubbed Bronze	\$ 770
MT1850-NL/PVDBRN	PVD Brushed Nickel	\$ 565
MT1850-NL/PVDPN	PVD Polished Nickel	\$ 565
MT1850-NL/ULB	Unlacquered Brass	\$ 511
MT1850-NL/VB	Venetian Bronze	\$ 770

Group 1 Finishes

All Group 1 Finishes **\$ 861**

Group 2 Finishes

All Group 2 Finishes **\$ 1013**

Hot Water Faucet with Traditional Double Curved Body & Curved Handle

MT1870-NL

- These Lead Free faucets are only compatible with the Little Gourmet® heating tank (MT641-3)
- 1/4 Turn Ceramic Cartridge
- 1-3/16" minimum to 1-3/8" maximum mounting hole required
- Heating tank is not included
- This hot water faucet is ICC listed
- Reverse Osmosis Safe
- NSF/ANSI/CAN 61: Q ≤ 1

Standard Finishes

MT1870-NL/BRS	Brushed Stainless	\$ 861
MT1870-NL/CHBRZ	Champagne Bronze	\$ 1013
MT1870-NL/CPB	Polished Chrome	\$ 511
MT1870-NL/MB	Matte Black	\$ 861
MT1870-NL/ORB	Oil Rubbed Bronze	\$ 770
MT1870-NL/PVDBRN	PVD Brushed Nickel	\$ 565
MT1870-NL/PVDPN	PVD Polished Nickel	\$ 565
MT1870-NL/ULB	Unlacquered Brass	\$ 511
MT1870-NL/VB	Venetian Bronze	\$ 770

Group 1 Finishes

All Group 1 Finishes **\$ 861**

Group 2 Finishes

All Group 2 Finishes **\$ 1013**



Little Gourmet
Premium Hot Water Dispenser

See the Little Gourmet® Premium Hot Water Dispenser on Page 69

Francis Anthony
Collection



MT1800DIY-NL



MT1820DIY-NL

Hot Water Faucet with Modern Curved Body & Handle Handle & Little Gourmet® Premium Hot Water Tank

MT1800DIY-NL

- 1/4 Turn Ceramic Cartridge
- 1-3/16" minimum to 1-3/8" maximum mounting hole required
- This hot water faucet is ICC listed
- Reverse Osmosis Safe
- NSF/ANSI/CAN 61: Q ≤ 1

Standard Finishes

MT1800DIY-NL/CHBRZ	Champagne Bronze	\$ 1737
MT1800DIY-NL/CPB	Polished Chrome	\$ 1234
MT1800DIY-NL/MB	Matte Black	\$ 1584
MT1800DIY-NL/ORB	Oil Rubbed Bronze	\$ 1494
MT1800DIY-NL/PVDBRN	PVD Brushed Nickel	\$ 1288
MT1800DIY-NL/PVDPN	PVD Polished Nickel	\$ 1288
MT1800DIY-NL/VB	Venetian Bronze	\$ 1494

Group 1 Finishes

All Group 1 Finishes **\$ 1584**

Group 2 Finishes

All Group 2 Finishes **\$ 1737**

Hot Water Faucet with Contemporary Round Body & Handle (120° Spout) & Little Gourmet® Premium Hot Water Tank

MT1820DIY-NL

- 1/4 Turn Ceramic Cartridge
- 1-3/16" minimum to 1-3/8" maximum mounting hole required
- This hot water faucet is ICC listed
- Reverse Osmosis Safe
- NSF/ANSI/CAN 61: Q ≤ 1

Standard Finishes

MT1820DIY-NL/BRS	Brushed Stainless	\$ 1508
MT1820DIY-NL/CHBRZ	Champagne Bronze	\$ 1647
MT1820DIY-NL/CPB	Polished Chrome	\$ 1188
MT1820DIY-NL/MB	Matte Black	\$ 1508
MT1820DIY-NL/ORB	Oil Rubbed Bronze	\$ 1425
MT1820DIY-NL/PVDBRN	PVD Brushed Nickel	\$ 1238
MT1820DIY-NL/PVDPN	PVD Polished Nickel	\$ 1238
MT1820DIY-NL/ULB	Unlacquered Brass	\$ 1188
MT1820DIY-NL/VB	Venetian Bronze	\$ 1425

Group 1 Finishes

All Group 1 Finishes **\$ 1508**

Group 2 Finishes

All Group 2 Finishes **\$ 1647**



Francis Anthony Collection



MT1830DIY-NL



MT1840DIY-NL



Hot Water Faucet with Contemporary Round Body & Handle (90° Spout) & Little Gourmet® Premium Hot Water Tank

MT1830DIY-NL

- 1/4 Turn Ceramic Cartridge
- 1-3/16" minimum to 1-3/8" maximum mounting hole required
- This hot water faucet is ICC listed
- Reverse Osmosis Safe
- NSF/ANSI/CAN 61: Q ≤ 1

Standard Finishes

MT1830DIY-NL/BRS	Brushed Stainless	\$ 1584
MT1830DIY-NL/CHBRZ	Champagne Bronze	\$ 1737
MT1830DIY-NL/CPB	Polished Chrome	\$ 1234
MT1830DIY-NL/MB	Matte Black	\$ 1584
MT1830DIY-NL/ORB	Oil Rubbed Bronze	\$ 1494
MT1830DIY-NL/PVDBRN	PVD Brushed Nickel	\$ 1288
MT1830DIY-NL/PVDPN	PVD Polished Nickel	\$ 1288
MT1830DIY-NL/ULB	Unlacquered Brass	\$ 1234
MT1830DIY-NL/VB	Venetian Bronze	\$ 1494

Group 1 Finishes

All Group 1 Finishes **\$ 1584**

Group 2 Finishes

All Group 2 Finishes **\$ 1737**

Hot Water Faucet with Contemporary Round Body & Handle & Little Gourmet® Premium Hot Water Tank

MT1840DIY-NL

- 1/4 Turn Ceramic Cartridge
- 1-3/16" minimum to 1-3/8" maximum mounting hole required
- This hot water faucet is ICC listed
- Reverse Osmosis Safe
- NSF/ANSI/CAN 61: Q ≤ 1

* **MT1840/SS Replaces Discontinued MT1400/SS**

Standard Finishes

MT1840DIY/SS	Stainless Steel	\$ 1584
MT1840DIY-NL/CHBRZ	Champagne Bronze	\$ 1737
MT1840DIY-NL/CPB	Polished Chrome	\$ 1234
MT1840DIY-NL/MB	Matte Black	\$ 1584
MT1840DIY-NL/ORB	Oil Rubbed Bronze	\$ 1494
MT1840DIY-NL/PVDBRN	PVD Brushed Nickel	\$ 1288
MT1840DIY-NL/PVDPN	PVD Polished Nickel	\$ 1288
MT1840DIY-NL/ULB	Unlacquered Brass	\$ 1234
MT1840DIY-NL/VB	Venetian Bronze	\$ 1494

Group 1 Finishes

All Group 1 Finishes **\$ 1584**

Group 2 Finishes

All Group 2 Finishes **\$ 1737**

Francis Anthony Collection



MT1850DIY-NL RO COMPATIBLE



MT1870DIY-NL

Hot Water Faucet with Traditional Curved Body & Curved Handle & Little Gourmet® Premium Hot Water Tank

MT1850DIY-NL

- 1/4 Turn Ceramic Cartridge
- 1-3/16" minimum to 1-3/8" maximum mounting hole required
- This hot water faucet is ICC listed
- Reverse Osmosis Safe
- NSF/ANSI/CAN 61: Q ≤ 1

Standard Finishes

MT1850DIY-NL/BRS	Brushed Stainless	\$ 1584
MT1850DIY-NL/CHBRZ	Champagne Bronze	\$ 1737
MT1850DIY-NL/CPB	Polished Chrome	\$ 1234
MT1850DIY-NL/MB	Matte Black	\$ 1584
MT1850DIY-NL/ORB	Oil Rubbed Bronze	\$ 1494
MT1850DIY-NL/PVDBRN	PVD Brushed Nickel	\$ 1288
MT1850DIY-NL/PVDPN	PVD Polished Nickel	\$ 1288
MT1850DIY-NL/ULB	Unlacquered Brass	\$ 1234
MT1850DIY-NL/VB	Venetian Bronze	\$ 1494

Group 1 Finishes

All Group 1 Finishes **\$ 1584**

Group 2 Finishes

All Group 2 Finishes **\$ 1737**

Hot Water Faucet with Traditional Double Curved Body & Curved Handle & Little Gourmet® Premium Hot Water Tank

MT1870DIY-NL

- 1/4 Turn Ceramic Cartridge
- 1-3/16" minimum to 1-3/8" maximum mounting hole required
- This hot water faucet is ICC listed
- Reverse Osmosis Safe
- NSF/ANSI/CAN 61: Q ≤ 1

Standard Finishes

MT1870DIY-NL/BRS	Brushed Stainless	\$ 1584
MT1870DIY-NL/CHBRZ	Champagne Bronze	\$ 1737
MT1870DIY-NL/CPB	Polished Chrome	\$ 1234
MT1870DIY-NL/MB	Matte Black	\$ 1584
MT1870DIY-NL/ORB	Oil Rubbed Bronze	\$ 1494
MT1870DIY-NL/PVDBRN	PVD Brushed Nickel	\$ 1288
MT1870DIY-NL/PVDPN	PVD Polished Nickel	\$ 1288
MT1870DIY-NL/ULB	Unlacquered Brass	\$ 1234
MT1870DIY-NL/VB	Venetian Bronze	\$ 1494

Group 1 Finishes

All Group 1 Finishes **\$ 1584**

Group 2 Finishes

All Group 2 Finishes **\$ 1737**

Hot & Cold Water Faucets Table of Contents

Image	Model Number	Duet Finishes	Knurling	Industrial Handle	Page
	MT1801-NL	NO	NO	NO	90
	MT1821-NL	YES	YES	NO	91
	MT1821-NLIH	NO	NO	YES	92
	MT1831-NL	YES	YES	NO	93
	MT1831-NLIH	NO	NO	YES	94
	MT1841-NL	YES	YES	NO	95
	MT1841-NLIH	NO	NO	YES	96
	MT1851-NL	NO	NO	NO	97
	MT1871-NL	NO	NO	NO	97
	MT1881-NL	NO	NO	NO	98

For Hot Tank

Francis Anthony Collection
76 - 84

Francis Anthony + Little
Gourmet® Packages
85 - 88

For Filters, Chiller, & Hot Tank

Francis Anthony Collection
90 - 98

Francis Anthony + Little
Gourmet® Packages
99 - 102

For Filters & Chiller

Francis Anthony Collection
104 - 112

Additional Collections
113 - 114

Francis Anthony + Mountain
Pure® Filter Packages
115 - 118

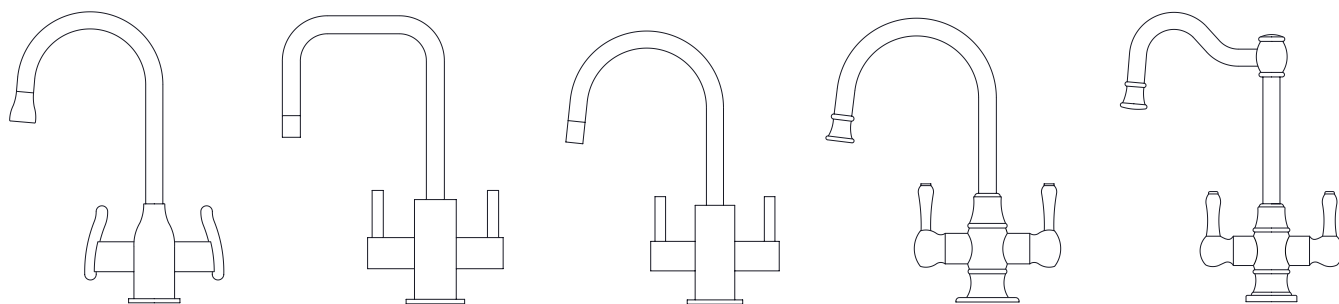

Francis Anthony Collection



MT1801-NL

Hot & Cold Water Faucet with Modern Curved Body & Handles

MT1801-NL

- These Lead Free faucets are only compatible with the Little Gourmet® heating tank (MT641-3)
- 1/4 Turn Ceramic Cartridge
- 1-3/16" minimum to 1-3/8" maximum mounting hole required
- Heating tank is not included
- This hot & cold water faucet is ICC listed
- Reverse Osmosis Safe
- NSF/ANSI/CAN 61: Q ≤ 1

Standard Finishes

MT1801-NL/CHBRZ	Champagne Bronze	\$ 1285
MT1801-NL/CPB	Polished Chrome	\$ 684
MT1801-NL/MB	Matte Black	\$ 1091
MT1801-NL/ORB	Oil Rubbed Bronze	\$ 974
MT1801-NL/PVDBRN	PVD Brushed Nickel	\$ 770
MT1801-NL/PVDPN	PVD Polished Nickel	\$ 770
MT1801-NL/VB	Venetian Bronze	\$ 974

Group 1 Finishes

All Group 1 Finishes \$ 1091

Group 2 Finishes

All Group 2 Finishes \$ 1285



Francis Anthony Collection

Hot & Cold Water Faucet with Contemporary Round Body & Handles (120° Spout)



- MT1821-NL**
- These Lead Free faucets are only compatible with the Little Gourmet® heating tank (MT641-3)
 - 1/4 Turn Ceramic Cartridge
 - 1-3/16" minimum to 1-3/8" maximum mounting hole required
 - Heating tank is not included
 - This hot & cold water faucet is ICC listed
 - Reverse Osmosis Safe
 - NSF/ANSI/CAN 61: Q ≤ 1

Standard Finishes

MT1821-NL/BRS	Brushed Stainless	\$ 1143
MT1821-NL/CHBRZ	Champagne Bronze	\$ 1348
MT1821-NL/CPB	Polished Chrome	\$ 715
MT1821-NL/MB	Matte Black	\$ 1143
MT1821-NL/ORB	Oil Rubbed Bronze	\$ 1021
MT1821-NL/PVDBRN	PVD Brushed Nickel	\$ 806
MT1821-NL/PVDPN	PVD Polished Nickel	\$ 806
MT1821-NL/ULB	Unlacquered Brass	\$ 715
MT1821-NL/VB	Venetian Bronze	\$ 1021

Group 1 Finishes
All Group 1 Finishes **\$ 1143**

Group 2 Finishes
All Group 2 Finishes **\$ 1348**

Duet Finishes (Matte Black is the Base Color for All Duet Products)

MT1821-NLD/PVDBRN	Brushed Nickel	\$ 1229
MT1821-NLD/CHBRZ	Champagne Bronze	\$ 1229
MT1821-NLD/CPB	Polished Chrome	\$ 1229
MT1821-NLD/PVDPN	Polished Nickel	\$ 1229

Knurled Duet Finishes (Matte Black is the Base Color for All Duet Products)

MT1821-NLDK/PVDBRN	Brushed Nickel	\$ 1341
MT1821-NLDK/CHBRZ	Champagne Bronze	\$ 1341
MT1821-NLDK/CPB	Polished Chrome	\$ 1341
MT1821-NLDK/PVDPN	Polished Nickel	\$ 1341

Knurled Accent Only (Knurling Added to Handle and Faucet Tip)

MT1821-NLK/PVDBRN	Brushed Nickel	\$ 1341
MT1821-NLK/CHBRZ	Champagne Bronze	\$ 1341
MT1821-NLK/CPB	Polished Chrome	\$ 1341
MT1821-NLK/PVDPN	Polished Nickel	\$ 1341

MT1821 Duet Finish Combinations

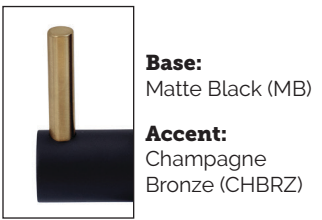
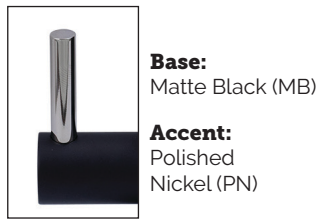
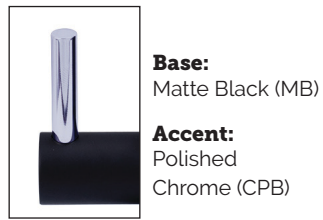
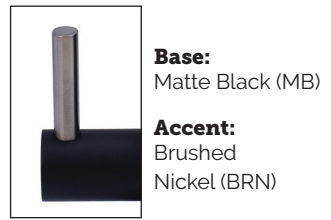

Hot & Cold Water Faucet with Contemporary Round Body & Handles (90° Spout)



MT1831-NL

Duet

Knurled



Francis Anthony
Collection

MT1831-NL

- These Lead Free faucets are only compatible with the Little Gourmet® heating tank (MT641-3)
- 1/4 Turn Ceramic Cartridge
- 1-3/16" minimum to 1-3/8" maximum mounting hole required
- Heating tank is not included
- This hot & cold water faucet is ICC listed
- Reverse Osmosis Safe
- NSF/ANSI/CAN 61: Q ≤ 1

Standard Finishes

MT1831-NL/BRS	Brushed Stainless	\$ 1091
MT1831-NL/CHBRZ	Champagne Bronze	\$ 1285
MT1831-NL/CPB	Polished Chrome	\$ 684
MT1831-NL/MB	Matte Black	\$ 1091
MT1831-NL/ORB	Oil Rubbed Bronze	\$ 974
MT1831-NL/PVDBRN	PVD Brushed Nickel	\$ 770
MT1831-NL/PVDPN	PVD Polished Nickel	\$ 770
MT1831-NL/ULB	Unlacquered Brass	\$ 684
MT1831-NL/VB	Venetian Bronze	\$ 974

Group 1 Finishes

All Group 1 Finishes	\$ 1091
----------------------	----------------

Group 2 Finishes

All Group 2 Finishes	\$ 1285
----------------------	----------------

Duet Finishes

(Matte Black is the Base Color for All Duet Products)

MT1831-NLD/PVDBRN	Brushed Nickel	\$ 1189
MT1831-NLD/CHBRZ	Champagne Bronze	\$ 1189
MT1831-NLD/CPB	Polished Chrome	\$ 1189
MT1831-NLD/PVDPN	Polished Nickel	\$ 1189

Knurled Duet Finishes

(Matte Black is the Base Color for All Duet Products)

MT1831-NLDK/PVDBRN	Brushed Nickel	\$ 1302
MT1831-NLDK/CHBRZ	Champagne Bronze	\$ 1302
MT1831-NLDK/CPB	Polished Chrome	\$ 1302
MT1831-NLDK/PVDPN	Polished Nickel	\$ 1302

Knurled Accent Only

(Knurling Added to Handle and Faucet Tip)

MT1831-NLK/PVDBRN	Brushed Nickel	\$ 1302
MT1831-NLK/CHBRZ	Champagne Bronze	\$ 1302
MT1831-NLK/CPB	Polished Chrome	\$ 1302
MT1831-NLK/PVDPN	Polished Nickel	\$ 1302

MT1831 Duet Finish Combinations



Base:
Matte Black (MB)

Accent:
Brushed Nickel (BRN)



Base:
Matte Black (MB)

Accent:
Polished Chrome (CPB)



Base:
Matte Black (MB)

Accent:
Polished Nickel (PN)



Base:
Matte Black (MB)

Accent:
Champagne Bronze (CHBRZ)

Hot & Cold Water Faucet with Contemporary Round Body & Handles



MT1841-NL



Francis Anthony Collection

MT1841-NL

- These Lead Free faucets are only compatible with the Little Gourmet® heating tank (MT641-3)
- 1/4 Turn Ceramic Cartridge
- 1-3/16" minimum to 1-3/8" maximum mounting hole required
- Heating tank is not included
- This hot & cold water faucet is ICC listed
- Reverse Osmosis Safe
- NSF/ANSI/CAN 61: Q ≤ 1

* MT1841/SS Replaces Discontinued MT1401/SS

Standard Finishes

MT1841/SS	Stainless Steel	\$ 1091
MT1841-NL/CHBRZ	Champagne Bronze	\$ 1285
MT1841-NL/CPB	Polished Chrome	\$ 684
MT1841-NL/MB	Matte Black	\$ 1091
MT1841-NL/ORB	Oil Rubbed Bronze	\$ 974
MT1841-NL/PVDBRN	PVD Brushed Nickel	\$ 770
MT1841-NL/PVDPN	PVD Polished Nickel	\$ 770
MT1841-NL/ULB	Unlacquered Brass	\$ 684
MT1841-NL/VB	Venetian Bronze	\$ 974

Group 1 Finishes

All Group 1 Finishes	\$ 1091
----------------------	----------------

Group 2 Finishes

All Group 2 Finishes	\$ 1285
----------------------	----------------

Duet Finishes

(Matte Black is the Base Color for All Duet Products)

MT1841-NLD/PVDBRN	Brushed Nickel	\$ 1189
MT1841-NLD/CHBRZ	Champagne Bronze	\$ 1189
MT1841-NLD/CPB	Polished Chrome	\$ 1189
MT1841-NLD/PVDPN	Polished Nickel	\$ 1189

Knurled Duet Finishes

(Matte Black is the Base Color for All Duet Products)

MT1841-NLDK/PVDBRN	Brushed Nickel	\$ 1302
MT1841-NLDK/CHBRZ	Champagne Bronze	\$ 1302
MT1841-NLDK/CPB	Polished Chrome	\$ 1302
MT1841-NLDK/PVDPN	Polished Nickel	\$ 1302

Knurled Accent Only

(Knurling Added to Handle and Faucet Tip)

MT1841-NLK/PVDBRN	Brushed Nickel	\$ 1302
MT1841-NLK/CHBRZ	Champagne Bronze	\$ 1302
MT1841-NLK/CPB	Polished Chrome	\$ 1302
MT1841-NLK/PVDPN	Polished Nickel	\$ 1302

MT1841 Duet Finish Combinations



Base:
Matte Black (MB)
Accent:
Brushed Nickel (BRN)



Base:
Matte Black (MB)
Accent:
Polished Chrome (CPB)



Base:
Matte Black (MB)
Accent:
Polished Nickel (PN)



Base:
Matte Black (MB)
Accent:
Champagne Bronze (CHBRZ)



MT1851-NL

Francis Anthony
Collection

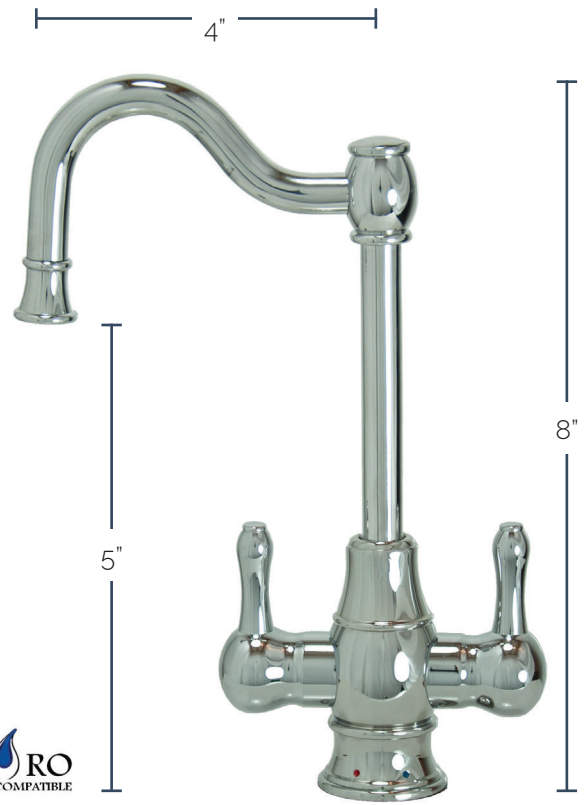

MT1871-NL

Francis Anthony
Collection

Hot & Cold Water Faucet with Traditional Curved Body & Curved Handles

MT1851-NL

- These Lead Free faucets are only compatible with the Little Gourmet® heating tank (MT641-3)
- 1/4 Turn Ceramic Cartridge
- 1-3/16" minimum to 1-3/8" maximum mounting hole required
- Heating tank is not included
- This hot & cold water faucet is ICC listed
- Reverse Osmosis Safe
- NSF/ANSI/CAN 61: Q ≤ 1

Standard Finishes

MT1851-NL/BRS	Brushed Stainless	\$ 1091
MT1851-NL/CHBRZ	Champagne Bronze	\$ 1285
MT1851-NL/CPB	Polished Chrome	\$ 684
MT1851-NL/MB	Matte Black	\$ 1091
MT1851-NL/ORB	Oil Rubbed Bronze	\$ 974
MT1851-NL/PVDBRN	PVD Brushed Nickel	\$ 770
MT1851-NL/PVDPN	PVD Polished Nickel	\$ 770
MT1851-NL/ULB	Unlacquered Brass	\$ 684
MT1851-NL/VB	Venetian Bronze	\$ 974

Group 1 Finishes

All Group 1 Finishes **\$ 1091**

Group 2 Finishes

All Group 2 Finishes **\$ 1285**

Hot & Cold Water Faucet with Traditional Double Curved Body & Curved Handles

MT1871-NL

- These Lead Free faucets are only compatible with the Little Gourmet® heating tank (MT641-3)
- 1/4 Turn Ceramic Cartridge
- 1-3/16" minimum to 1-3/8" maximum mounting hole required
- Heating tank is not included
- This hot & cold water faucet is ICC listed
- Reverse Osmosis Safe
- NSF/ANSI/CAN 61: Q ≤ 1

Standard Finishes

MT1871-NL/BRS	Brushed Stainless	\$ 1091
MT1871-NL/CHBRZ	Champagne Bronze	\$ 1285
MT1871-NL/CPB	Polished Chrome	\$ 684
MT1871-NL/MB	Matte Black	\$ 1091
MT1871-NL/ORB	Oil Rubbed Bronze	\$ 974
MT1871-NL/PVDBRN	PVD Brushed Nickel	\$ 770
MT1871-NL/PVDPN	PVD Polished Nickel	\$ 770
MT1871-NL/ULB	Unlacquered Brass	\$ 684
MT1871-NL/VB	Venetian Bronze	\$ 974

Group 1 Finishes

All Group 1 Finishes **\$ 1091**

Group 2 Finishes

All Group 2 Finishes **\$ 1285**



Little Gourmet
Premium Hot Water Dispenser

See the Little Gourmet® Premium Hot Water Dispenser on Page 69

Francis Anthony
Collection



MT1801DIY-NL



Hot & Cold Water Faucet with Modern Curved Body & Handles & Little Gourmet® Premium Hot Water Tank

MT1801DIY-NL

- 1/4 Turn Ceramic Cartridge
- 1-3/16" minimum to 1-3/8" maximum mounting hole required
- This hot & cold water faucet is ICC listed
- Reverse Osmosis Safe
- NSF/ANSI/CAN 61: Q ≤ 1

Standard Finishes

MT1801DIY-NL/CHBRZ	Champagne Bronze	\$ 2009
MT1801DIY-NL/CPB	Polished Chrome	\$ 1407
MT1801DIY-NL/MB	Matte Black	\$ 1814
MT1801DIY-NL/ORB	Oil Rubbed Bronze	\$ 1698
MT1801DIY-NL/PVDBRN	PVD Brushed Nickel	\$ 1494
MT1801DIY-NL/PVDPN	PVD Polished Nickel	\$ 1494
MT1801DIY-NL/VB	Venetian Bronze	\$ 1698

Group 1 Finishes

All Group 1 Finishes **\$ 1814**

Group 2 Finishes

All Group 2 Finishes **\$ 2009**



MT1821DIY-NL



Hot & Cold Water Faucet with Contemporary Round Body & Handles (120° Spout) & Little Gourmet® Premium Hot Water Tank

MT1821DIY-NL

- 1/4 Turn Ceramic Cartridge
- 1-3/16" minimum to 1-3/8" maximum mounting hole required
- This hot & cold water faucet is ICC listed
- Reverse Osmosis Safe
- NSF/ANSI/CAN 61: Q ≤ 1

Standard Finishes

MT1821DIY-NL/BRS	Brushed Stainless	\$ 1866
MT1821DIY-NL/CHBRZ	Champagne Bronze	\$ 2071
MT1821DIY-NL/CPB	Polished Chrome	\$ 1439
MT1821DIY-NL/MB	Matte Black	\$ 1866
MT1821DIY-NL/ORB	Oil Rubbed Bronze	\$ 1744
MT1821DIY-NL/PVDBRN	PVD Brushed Nickel	\$ 1529
MT1821DIY-NL/PVDPN	PVD Polished Nickel	\$ 1529
MT1821DIY-NL/ULB	Unlacquered Brass	\$ 1439
MT1821DIY-NL/VB	Venetian Bronze	\$ 1744

Group 1 Finishes

All Group 1 Finishes **\$ 1866**

Group 2 Finishes

All Group 2 Finishes **\$ 2071**



Francis Anthony Collection



MT1831DIY-NL



MT1841DIY-NL

Hot & Cold Water Faucet with Contemporary Round Body & Handles (90° Spout) & Little Gourmet® Premium Hot Water Tank

MT1831DIY-NL

- 1/4 Turn Ceramic Cartridge
- 1-3/16" minimum to 1-3/8" maximum mounting hole required
- This hot & cold water faucet is ICC listed
- Reverse Osmosis Safe
- NSF/ANSI/CAN 61: Q ≤ 1

Standard Finishes

MT1831DIY-NL/BRS	Brushed Stainless	\$ 1814
MT1831DIY-NL/CHBRZ	Champagne Bronze	\$ 2009
MT1831DIY-NL/CPB	Polished Chrome	\$ 1407
MT1831DIY-NL/MB	Matte Black	\$ 1814
MT1831DIY-NL/ORB	Oil Rubbed Bronze	\$ 1698
MT1831DIY-NL/PVDBRN	PVD Brushed Nickel	\$ 1494
MT1831DIY-NL/PVDPN	PVD Polished Nickel	\$ 1494
MT1831DIY-NL/ULB	Unlacquered Brass	\$ 1407
MT1831DIY-NL/VB	Venetian Bronze	\$ 1698

Group 1 Finishes

All Group 1 Finishes **\$ 1814**

Group 2 Finishes

All Group 2 Finishes **\$ 2009**

Hot & Cold Water Faucet with Contemporary Round Body & Handles & Little Gourmet® Premium Hot Water Tank

MT1841DIY-NL

- 1/4 Turn Ceramic Cartridge
- 1-3/16" minimum to 1-3/8" maximum mounting hole required
- This hot & cold water faucet is ICC listed
- Reverse Osmosis Safe
- NSF/ANSI/CAN 61: Q ≤ 1

* **MT1841/SS Replaces Discontinued MT1401/SS**

Standard Finishes

MT1841DIY/SS	Stainless Steel	\$ 1767
MT1841DIY-NL/CHBRZ	Champagne Bronze	\$ 1954
MT1841DIY-NL/CPB	Polished Chrome	\$ 1377
MT1841DIY-NL/MB	Matte Black	\$ 1767
MT1841DIY-NL/ORB	Oil Rubbed Bronze	\$ 1655
MT1841DIY-NL/PVDBRN	PVD Brushed Nickel	\$ 1460
MT1841DIY-NL/PVDPN	PVD Polished Nickel	\$ 1460
MT1841DIY-NL/ULB	Unlacquered Brass	\$ 1377
MT1841DIY-NL/VB	Venetian Bronze	\$ 1655

Group 1 Finishes

All Group 1 Finishes **\$ 1767**

Group 2 Finishes

All Group 2 Finishes **\$ 1954**

Francis Anthony Collection



MT1851DIY-NL



MT1871DIY-NL

Hot & Cold Water Faucet with Traditional Curved Body & Curved Handles & Little Gourmet® Premium Hot Water Tank

Hot & Cold Water Faucet with Traditional Double Curved Body & Curved Handles & Little Gourmet® Premium Hot Water Tank

MT1851DIY-NL

- 1/4 Turn Ceramic Cartridge
- 1-3/16" minimum to 1-3/8" maximum mounting hole required
- This hot & cold water faucet is ICC listed
- Reverse Osmosis Safe
- NSF/ANSI/CAN 61: Q ≤ 1

MT1871DIY-NL

- 1/4 Turn Ceramic Cartridge
- 1-3/16" minimum to 1-3/8" maximum mounting hole required
- This hot & cold water faucet is ICC listed
- Reverse Osmosis Safe
- NSF/ANSI/CAN 61: Q ≤ 1

Standard Finishes

MT1851DIY-NL/BRS	Brushed Stainless	\$ 1814
MT1851DIY-NL/CHBRZ	Champagne Bronze	\$ 2009
MT1851DIY-NL/CPB	Polished Chrome	\$ 1407
MT1851DIY-NL/MB	Matte Black	\$ 1814
MT1851DIY-NL/ORB	Oil Rubbed Bronze	\$ 1698
MT1851DIY-NL/PVDBRN	PVD Brushed Nickel	\$ 1494
MT1851DIY-NL/PVDPN	PVD Polished Nickel	\$ 1494
MT1851DIY-NL/ULB	Unlacquered Brass	\$ 1407
MT1851DIY-NL/VB	Venetian Bronze	\$ 1698

Group 1 Finishes

All Group 1 Finishes **\$ 1814**

Group 2 Finishes

All Group 2 Finishes **\$ 2009**

Standard Finishes

MT1871DIY-NL/BRS	Brushed Stainless	\$ 1814
MT1871DIY-NL/CHBRZ	Champagne Bronze	\$ 2009
MT1871DIY-NL/CPB	Polished Chrome	\$ 1407
MT1871DIY-NL/MB	Matte Black	\$ 1814
MT1871DIY-NL/ORB	Oil Rubbed Bronze	\$ 1698
MT1871DIY-NL/PVDBRN	PVD Brushed Nickel	\$ 1494
MT1871DIY-NL/PVDPN	PVD Polished Nickel	\$ 1494
MT1871DIY-NL/ULB	Unlacquered Brass	\$ 1407
MT1871DIY-NL/VB	Venetian Bronze	\$ 1698











Group 1 Finishes

All Group 1 Finishes **\$ 1814**

Group 2 Finishes

All Group 2 Finishes **\$ 2009**

Point-of-Use Water Faucets Table of Contents

Image	Model Number	Duet Finishes	Knurling	Industrial Handle	Page
	MT1803-NL	NO	NO	NO	104
	MT1823-NL	YES	YES	NO	105
	MT1823-NLIH	NO	NO	YES	106
	MT1833-NL	YES	YES	NO	107
	MT1833-NLIH	NO	NO	YES	108
	MT1843-NL	YES	YES	NO	109
	MT1843-NLIH	NO	NO	YES	110
	MT1853-NL	NO	NO	NO	111
	MT1873-NL	NO	NO	NO	111
	MT1883-NL	NO	NO	NO	112

For Hot Tank

Francis Anthony Collection
76 - 84

Francis Anthony + Little
Gourmet® Packages
85 - 88

For Filters, Chiller, & Hot Tank

Francis Anthony Collection
90 - 98

Francis Anthony + Little
Gourmet® Packages
99 - 102

For Filters & Chiller

Francis Anthony Collection
104 - 112

Additional Collections
113 - 114

Francis Anthony + Mountain
Pure® Filter Packages
115 - 118

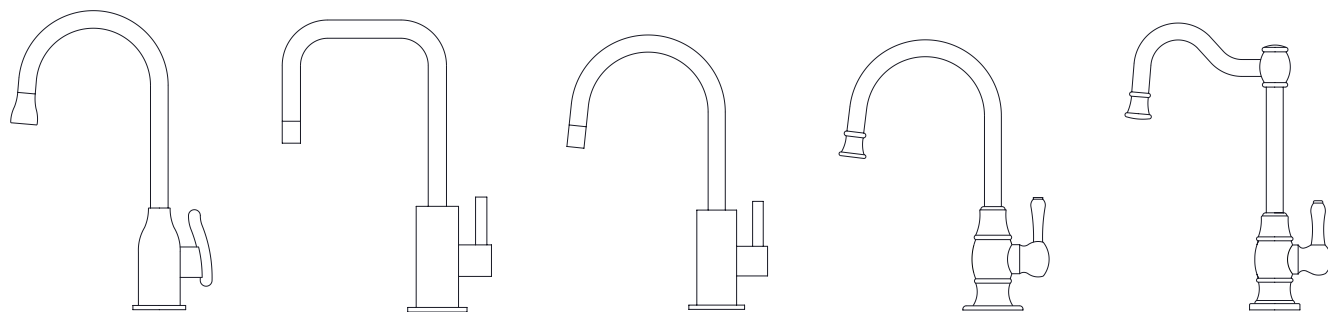

Francis Anthony Collection



Point-of-Use Drinking Faucet with Modern Curved Body & Handle

MT1803-NL

- 1/4 Turn Ceramic Cartridge
- These faucets are constructed with lead free brass
- 1/2" minimum to 1-3/8" maximum mounting hole required
- This drinking water faucet is ICC listed
- Reverse Osmosis Safe
- NSF/ANSI/CAN 61: Q ≤ 1

Standard Finishes

MT1803-NL/CHBRZ	Champagne Bronze	\$ 775
MT1803-NL/CPB	Polished Chrome	\$ 322
MT1803-NL/MB	Matte Black	\$ 657
MT1803-NL/ORB	Oil Rubbed Bronze	\$ 585
MT1803-NL/PVDBRN	PVD Brushed Nickel	\$ 391
MT1803-NL/PVDPN	PVD Polished Nickel	\$ 391
MT1803-NL/VB	Venetian Bronze	\$ 585

Group 1 Finishes

All Group 1 Finishes **\$ 657**

Group 2 Finishes

All Group 2 Finishes **\$ 775**



Francis Anthony Collection

MT1803-NL



Point-of-Use Drinking Faucet with Contemporary Round Body & Handle (120° Spout)

- MT1823-NL**
- 1/4 Turn Ceramic Cartridge
 - These faucets are constructed with lead free brass
 - 1/2" minimum to 1-3/8" maximum mounting hole required
 - This drinking water faucet is ICC listed
 - Reverse Osmosis Safe
 - NSF/ANSI/CAN 61: Q ≤ 1

Standard Finishes

MT1823-NL/BRS	Brushed Stainless	\$ 688
MT1823-NL/CHBRZ	Champagne Bronze	\$ 811
MT1823-NL/CPB	Polished Chrome	\$ 338
MT1823-NL/MB	Matte Black	\$ 688
MT1823-NL/ORB	Oil Rubbed Bronze	\$ 613
MT1823-NL/PVDBRN	PVD Brushed Nickel	\$ 410
MT1823-NL/PVDPN	PVD Polished Nickel	\$ 410
MT1823-NL/ULB	Unlacquered Brass	\$ 338
MT1823-NL/VB	Venetian Bronze	\$ 613

Group 1 Finishes

All Group 1 Finishes	\$ 688
----------------------	---------------

Group 2 Finishes

All Group 2 Finishes	\$ 811
----------------------	---------------

Duet Finishes

(Matte Black is the Base Color for All Duet Products)

MT1823-NLD/PVDBRN	Brushed Nickel	\$ 756
MT1823-NLD/CHBRZ	Champagne Bronze	\$ 756
MT1823-NLD/CPB	Polished Chrome	\$ 756
MT1823-NLD/PVDPN	Polished Nickel	\$ 756

Knurled Duet Finishes

(Matte Black is the Base Color for All Duet Products)

MT1823-NLDK/PVDBRN	Brushed Nickel	\$ 816
MT1823-NLDK/CHBRZ	Champagne Bronze	\$ 816
MT1823-NLDK/CPB	Polished Chrome	\$ 816
MT1823-NLDK/PVDPN	Polished Nickel	\$ 816

Knurled Accent Only

(Knurling Added to Handle and Faucet Tip)

MT1823-NLK/PVDBRN	Brushed Nickel	\$ 816
MT1823-NLK/CHBRZ	Champagne Bronze	\$ 816
MT1823-NLK/CPB	Polished Chrome	\$ 816
MT1823-NLK/PVDPN	Polished Nickel	\$ 816



Francis Anthony Collection

MT1823-NL

MT1823 Duet Finish Combinations

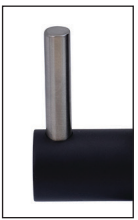

Base:
Matte Black (MB)

Accent:
Brushed Nickel (BRN)



Base:
Matte Black (MB)

Accent:
Polished Chrome (CPB)



Base:
Matte Black (MB)

Accent:
Polished Nickel (PN)



Base:
Matte Black (MB)

Accent:
Champagne Bronze (CHBRZ)



MT1833-NL

Duet

Knurled



Francis Anthony Collection

Point-of-Use Drinking Faucet with Contemporary Round Body & Handle (90° Spout)

MT1833-NL

- 1/4 Turn Ceramic Cartridge
- These faucets are constructed with lead free brass
- 1/2" minimum to 1-3/8" maximum mounting hole required
- This drinking water faucet is ICC listed
- Reverse Osmosis Safe
- NSF/ANSI/CAN 61: Q ≤ 1

Standard Finishes

MT1833-NL/BRS	Brushed Stainless	\$ 657
MT1833-NL/CHBRZ	Champagne Bronze	\$ 775
MT1833-NL/CPB	Polished Chrome	\$ 322
MT1833-NL/MB	Matte Black	\$ 657
MT1833-NL/ORB	Oil Rubbed Bronze	\$ 585
MT1833-NL/PVDBRN	PVD Brushed Nickel	\$ 391
MT1833-NL/PVDPN	PVD Polished Nickel	\$ 391
MT1833-NL/ULB	Unlacquered Brass	\$ 322
MT1833-NL/VB	Venetian Bronze	\$ 585

Group 1 Finishes

All Group 1 Finishes \$ 657

Group 2 Finishes

All Group 2 Finishes \$ 775

Duet Finishes

(Matte Black is the Base Color for All Duet Products)

MT1833-NLD/PVDBRN	Brushed Nickel	\$ 737
MT1833-NLD/CHBRZ	Champagne Bronze	\$ 737
MT1833-NLD/CPB	Polished Chrome	\$ 737
MT1833-NLD/PVDPN	Polished Nickel	\$ 737

Knurled Duet Finishes

(Matte Black is the Base Color for All Duet Products)

MT1833-NLDK/PVDBRN	Brushed Nickel	\$ 813
MT1833-NLDK/CHBRZ	Champagne Bronze	\$ 813
MT1833-NLDK/CPB	Polished Chrome	\$ 813
MT1833-NLDK/PVDPN	Polished Nickel	\$ 813

Knurled Accent Only

(Knurling Added to Handle and Faucet Tip)

MT1833-NLK/PVDBRN	Brushed Nickel	\$ 813
MT1833-NLK/CHBRZ	Champagne Bronze	\$ 813
MT1833-NLK/CPB	Polished Chrome	\$ 813
MT1833-NLK/PVDPN	Polished Nickel	\$ 813

MT1833 Duet Finish Combinations



Base:
Matte Black (MB)

Accent:
Brushed Nickel (BRN)



Base:
Matte Black (MB)

Accent:
Polished Chrome (CPB)



Base:
Matte Black (MB)

Accent:
Polished Nickel (PN)



Base:
Matte Black (MB)

Accent:
Champagne Bronze (CHBRZ)

Point-of-Use Drinking Faucet with Contemporary Round Body & Handle



MT1843-NL

- 1/4 Turn Ceramic Cartridge
- These faucets are constructed with lead free brass
- 1/2" minimum to 1-3/8" maximum mounting hole required
- This drinking water faucet is ICC listed
- Reverse Osmosis Safe
- NSF/ANSI/CAN 61: Q ≤ 1

* MT1843/SS Replaces Discontinued MT1403/SS

Standard Finishes

MT1843/SS	Stainless Steel	\$ 657
MT1843-NL/CHBRZ	Champagne Bronze	\$ 775
MT1843-NL/CPB	Polished Chrome	\$ 322
MT1843-NL/MB	Matte Black	\$ 657
MT1843-NL/ORB	Oil Rubbed Bronze	\$ 585
MT1843-NL/PVDBRN	PVD Brushed Nickel	\$ 391
MT1843-NL/PVDPN	PVD Polished Nickel	\$ 391
MT1843-NL/ULB	Unlacquered Brass	\$ 322
MT1843-NL/VB	Venetian Bronze	\$ 585

Group 1 Finishes

All Group 1 Finishes **\$ 657**

Group 2 Finishes

All Group 2 Finishes **\$ 775**

Duet Finishes

(Matte Black is the Base Color for All Duet Products)

MT1843-NLD/PVDBRN	Brushed Nickel	\$ 737
MT1843-NLD/CHBRZ	Champagne Bronze	\$ 737
MT1843-NLD/CPB	Polished Chrome	\$ 737
MT1843-NLD/PVDPN	Polished Nickel	\$ 737

Knurled Duet Finishes

(Matte Black is the Base Color for All Duet Products)

MT1843-NLDK/PVDBRN	Brushed Nickel	\$ 813
MT1843-NLDK/CHBRZ	Champagne Bronze	\$ 813
MT1843-NLDK/CPB	Polished Chrome	\$ 813
MT1843-NLDK/PVDPN	Polished Nickel	\$ 813

Knurled Accent Only

(Knurling Added to Handle and Faucet Tip)

MT1843-NLK/PVDBRN	Brushed Nickel	\$ 813
MT1843-NLK/CHBRZ	Champagne Bronze	\$ 813
MT1843-NLK/CPB	Polished Chrome	\$ 813
MT1843-NLK/PVDPN	Polished Nickel	\$ 813

Duet

Knurled



Francis Anthony Collection

MT1843 Duet Finish Combinations



Base:
Matte Black (MB)
Accent:
Brushed Nickel (BRN)



Base:
Matte Black (MB)
Accent:
Polished Chrome (CPB)



Base:
Matte Black (MB)
Accent:
Polished Nickel (PN)



Base:
Matte Black (MB)
Accent:
Champagne Bronze (CHBRZ)



Francis Anthony Collection

MT1853-NL



Francis Anthony Collection

MT1873-NL

Point-of-Use Drinking Faucet with Traditional Curved Body & Curved Handle

MT1853-NL

- 1/4 Turn Ceramic Cartridge
- These faucets are constructed with lead free brass
- 1/2" minimum to 1-3/8" maximum mounting hole required
- This drinking water faucet is ICC listed
- Reverse Osmosis Safe
- NSF/ANSI/CAN 61: Q ≤ 1

Standard Finishes

MT1853-NL/BRS	Brushed Stainless	\$ 657
MT1853-NL/CHBRZ	Champagne Bronze	\$ 775
MT1853-NL/CPB	Polished Chrome	\$ 322
MT1853-NL/MB	Matte Black	\$ 657
MT1853-NL/ORB	Oil Rubbed Bronze	\$ 585
MT1853-NL/PVDBRN	PVD Brushed Nickel	\$ 391
MT1853-NL/PVDPN	PVD Polished Nickel	\$ 391
MT1853-NL/ULB	Unlacquered Brass	\$ 322
MT1853-NL/VB	Venetian Bronze	\$ 585

Group 1 Finishes

All Group 1 Finishes **\$ 657**

Group 2 Finishes

All Group 2 Finishes **\$ 775**

Point-of-Use Drinking Faucet with Traditional Double Curved Body & Curved Handle

MT1873-NL

- 1/4 Turn Ceramic Cartridge
- These faucets are constructed with lead free brass
- 1/2" minimum to 1-3/8" maximum mounting hole required
- This drinking water faucet is ICC listed
- Reverse Osmosis Safe
- NSF/ANSI/CAN 61: Q ≤ 1

Standard Finishes

MT1873-NL/BRS	Brushed Stainless	\$ 657
MT1873-NL/CHBRZ	Champagne Bronze	\$ 775
MT1873-NL/CPB	Polished Chrome	\$ 322
MT1873-NL/MB	Matte Black	\$ 657
MT1873-NL/ORB	Oil Rubbed Bronze	\$ 585
MT1873-NL/PVDBRN	PVD Brushed Nickel	\$ 391
MT1873-NL/PVDPN	PVD Polished Nickel	\$ 391
MT1873-NL/ULB	Unlacquered Brass	\$ 322
MT1873-NL/VB	Venetian Bronze	\$ 585

Group 1 Finishes

All Group 1 Finishes **\$ 657**

Group 2 Finishes

All Group 2 Finishes **\$ 775**



Point-of-Use Drinking Faucet with Teardrop Body & Side Handle

MT600-NL

- 1/4 Turn Ceramic Cartridge
- 1/2" minimum to 1-3/8" maximum mounting hole required
- Optional AG1800 air gap may be required for Reverse Osmosis Filters
- This drinking water faucet is IAPMO listed
- Reverse Osmosis Safe
- NSF/ANSI/CAN 61: Q ≤ 1

Standard Finishes

MT600-NL/BRN	Brushed Nickel	\$ 340
MT600-NL/BRS	Brushed Stainless	\$ 403
MT600-NL/CHBRZ	Champagne Bronze	\$ 669
MT600-NL/CPB	Polished Chrome	\$ 271
MT600-NL/MB	Matte Black	\$ 474
MT600-NL/ORB	Oil Rubbed Bronze	\$ 442
MT600-NL/PN	Polished Nickel	\$ 340
MT600-NL/ULB	Unlacquered Brass	\$ 271
MT600-NL/VB	Venetian Bronze	\$ 442

Group 1 Finishes

All Group 1 Finishes **\$ 474**

Group 2 Finishes

All Group 2 Finishes **\$ 669**

Other Finishes

MT600-NL/WH White **\$ 339**



Point-of-Use Drinking Faucet with Round Tapered Body & Angled Side Handle

MT624-NL

- 1/4 Turn Ceramic Cartridge
- 1/2" minimum to 1-3/8" maximum mounting hole required
- Optional AG1800 air gap may be required for Reverse Osmosis Filters
- This drinking water faucet is IAPMO listed
- Reverse Osmosis Safe
- NSF/ANSI/CAN 61: Q ≤ 1

Standard Finishes

MT624-NL/BRN	Brushed Nickel	\$ 270
MT624-NL/BRS	Brushed Stainless	\$ 245
MT624-NL/CHBRZ	Champagne Bronze	\$ 442
MT624-NL/CPB	Polished Chrome	\$ 261
MT624-NL/MB	Matte Black	\$ 362
MT624-NL/ORB	Oil Rubbed Bronze	\$ 339
MT624-NL/PN	Polished Nickel	\$ 270
MT624-NL/ULB	Unlacquered Brass	\$ 261
MT624-NL/VB	Venetian Bronze	\$ 339

Group 1 Finishes

All Group 1 Finishes **\$ 362**

Group 2 Finishes

All Group 2 Finishes **\$ 442**



See the Mountain Pure® Water Filtration System on Page 71

Francis Anthony Collection



MT1803FIL-NL



MT1823FIL-NL

Point-of-Use Drinking Faucet with Modern Curved Body & Handle & Mountain Pure® Water Filtration System

MT1803FIL-NL

- 1/4 Turn Ceramic Cartridge
- These faucets are constructed from lead free brass
- 1/2" minimum to 1-3/8" maximum mounting hole required
- This drinking water faucet is ICC listed
- MT1250XL Water Filtration System included
- NSF/ANSI/CAN 61: Q ≤ 1

Standard Finishes

MT1803FIL-NL/CHBRZ	Champagne Bronze	\$ 1248
MT1803FIL-NL/CPB	Polished Chrome	\$ 795
MT1803FIL-NL/MB	Matte Black	\$ 1130
MT1803FIL-NL/ORB	Oil Rubbed Bronze	\$ 1058
MT1803FIL-NL/PVDBRN	PVD Brushed Nickel	\$ 864
MT1803FIL-NL/PVDPN	PVD Polished Nickel	\$ 864
MT1803FIL-NL/VB	Venetian Bronze	\$ 1058

Group 1 Finishes

All Group 1 Finishes **\$ 1130**

Group 2 Finishes

All Group 2 Finishes **\$ 1248**

Point-of-Use Drinking Faucet with Contemporary Round Body & Handle (120° Spout) & Mountain Pure® Water Filtration System

MT1823FIL-NL

- 1/4 Turn Ceramic Cartridge
- These faucets are constructed from lead free brass
- 1/2" minimum to 1-3/8" maximum mounting hole required
- This drinking water faucet is ICC listed
- MT1250XL Water Filtration System included
- NSF/ANSI/CAN 61: Q ≤ 1

Standard Finishes

MT1823FIL-NL/BRS	Brushed Stainless	\$ 1161
MT1823FIL-NL/CHBRZ	Champagne Bronze	\$ 1284
MT1823FIL-NL/CPB	Polished Chrome	\$ 811
MT1823FIL-NL/MB	Matte Black	\$ 1161
MT1823FIL-NL/ORB	Oil Rubbed Bronze	\$ 1086
MT1823FIL-NL/PVDBRN	PVD Brushed Nickel	\$ 883
MT1823FIL-NL/PVDPN	PVD Polished Nickel	\$ 883
MT1823FIL-NL/ULB	Unlacquered Brass	\$ 811
MT1823FIL-NL/VB	Venetian Bronze	\$ 1086

Group 1 Finishes

All Group 1 Finishes **\$ 1161**

Group 2 Finishes

All Group 2 Finishes **\$ 1284**



Francis Anthony Collection



MT1833FIL-NL



MT1843FIL-NL

Point-of-Use Drinking Faucet with Contemporary Round Body & Handle (90° Spout) & Mountain Pure® Water Filtration System

MT1833FIL-NL

- 1/4 Turn Ceramic Cartridge
- These faucets are constructed from lead free brass
- 1/2" minimum to 1-3/8" maximum mounting hole required
- This drinking water faucet is ICC listed
- MT1250XL Water Filtration System included
- NSF/ANSI/CAN 61: Q ≤ 1

Standard Finishes

MT1833FIL-NL/BRS	Brushed Stainless	\$ 1130
MT1833FIL-NL/CHBRZ	Champagne Bronze	\$ 1248
MT1833FIL-NL/CPB	Polished Chrome	\$ 795
MT1833FIL-NL/MB	Matte Black	\$ 1130
MT1833FIL-NL/ORB	Oil Rubbed Bronze	\$ 1058
MT1833FIL-NL/PVDBRN	PVD Brushed Nickel	\$ 864
MT1833FIL-NL/PVDPN	PVD Polished Nickel	\$ 864
MT1833FIL-NL/ULB	Unlacquered Brass	\$ 795
MT1833FIL-NL/VB	Venetian Bronze	\$ 1058

Group 1 Finishes

All Group 1 Finishes **\$ 1130**

Group 2 Finishes

All Group 2 Finishes **\$ 1248**

Point-of-Use Drinking Faucet with Contemporary Round Body & Handle & Mountain Pure® Water Filtration System

MT1843FIL-NL

- 1/4 Turn Ceramic Cartridge
- These faucets are constructed from lead free brass
- 1/2" minimum to 1-3/8" maximum mounting hole required
- This drinking water faucet is ICC listed
- MT1250XL Water Filtration System included
- NSF/ANSI/CAN 61: Q ≤ 1

* **MT1843/SS Replaces Discontinued MT1403/SS**

Standard Finishes

MT1843FIL/SS	Stainless Steel	\$ 1130
MT1843FIL-NL/CHBRZ	Champagne Bronze	\$ 1248
MT1843FIL-NL/CPB	Polished Chrome	\$ 795
MT1843FIL-NL/MB	Matte Black	\$ 1130
MT1843FIL-NL/ORB	Oil Rubbed Bronze	\$ 1058
MT1843FIL-NL/PVDBRN	PVD Brushed Nickel	\$ 864
MT1843FIL-NL/PVDPN	PVD Polished Nickel	\$ 864
MT1843FIL-NL/ULB	Unlacquered Brass	\$ 795
MT1843FIL-NL/VB	Venetian Bronze	\$ 1058

Group 1 Finishes

All Group 1 Finishes **\$ 1130**

Group 2 Finishes

All Group 2 Finishes **\$ 1248**

Francis Anthony Collection

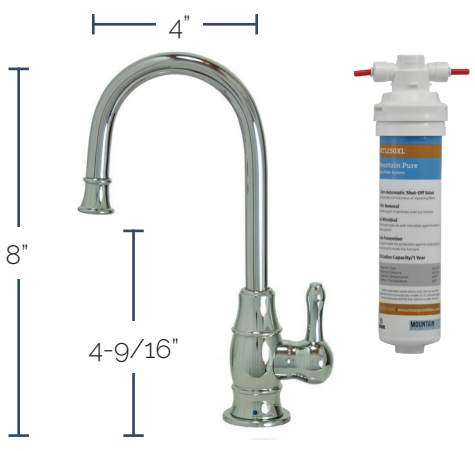

MT1853FIL-NL

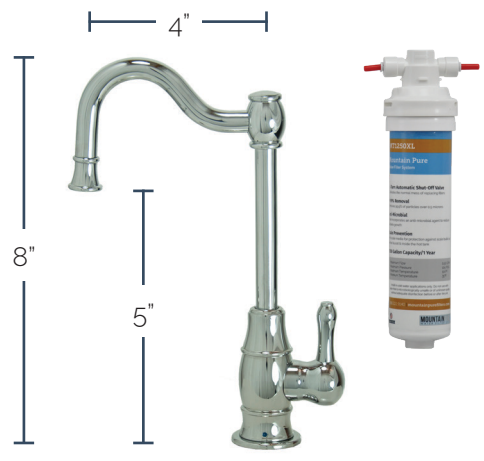

MT1873FIL-NL

Point-of-Use Drinking Faucet with Traditional Curved Body & Curved Handle & Mountain Pure® Water Filtration System

MT1853FIL-NL

- 1/4 Turn Ceramic Cartridge
- These faucets are constructed from lead free brass
- 1/2" minimum to 1-3/8" maximum mounting hole required
- This drinking water faucet is ICC listed
- MT1250XL Water Filtration System included
- NSF/ANSI/CAN 61: Q ≤ 1

Standard Finishes

MT1853FIL-NL/BRS	Brushed Stainless	\$ 1130
MT1853FIL-NL/CHBRZ	Champagne Bronze	\$ 1248
MT1853FIL-NL/CPB	Polished Chrome	\$ 795
MT1853FIL-NL/MB	Matte Black	\$ 1130
MT1853FIL-NL/ORB	Oil Rubbed Bronze	\$ 1058
MT1853FIL-NL/PVDBRN	PVD Brushed Nickel	\$ 864
MT1853FIL-NL/PVDPN	PVD Polished Nickel	\$ 864
MT1853FIL-NL/ULB	Unlacquered Brass	\$ 795
MT1853FIL-NL/VB	Venetian Bronze	\$ 1058

Group 1 Finishes

All Group 1 Finishes \$ 1130

Group 2 Finishes

All Group 2 Finishes \$ 1248

Point-of-Use Drinking Faucet with Traditional Double Curved Body & Curved Handle & Mountain Pure® Water Filtration System

MT1873FIL-NL

- 1/4 Turn Ceramic Cartridge
- These faucets are constructed from lead free brass
- 1/2" minimum to 1-3/8" maximum mounting hole required
- This drinking water faucet is ICC listed
- MT1250XL Water Filtration System included
- NSF/ANSI/CAN 61: Q ≤ 1

Standard Finishes

MT1873FIL-NL/BRS	Brushed Stainless	\$ 1130
MT1873FIL-NL/CHBRZ	Champagne Bronze	\$ 1248
MT1873FIL-NL/CPB	Polished Chrome	\$ 795
MT1873FIL-NL/MB	Matte Black	\$ 1130
MT1873FIL-NL/ORB	Oil Rubbed Bronze	\$ 1058
MT1873FIL-NL/PVDBRN	PVD Brushed Nickel	\$ 864
MT1873FIL-NL/PVDPN	PVD Polished Nickel	\$ 864
MT1873FIL-NL/ULB	Unlacquered Brass	\$ 795
MT1873FIL-NL/VB	Venetian Bronze	\$ 1058

Group 1 Finishes

All Group 1 Finishes \$ 1130

Group 2 Finishes

All Group 2 Finishes \$ 1248



Faucet Air Gap Unit for MT1823-NL, MT1833-NL, & MT1843-NL

AG1800

A reverse osmosis air gap usually required by the filter manufacturer and plumbing codes when installing select faucets.

- Requires two mounting holes
- For use with Little Gourmet® point of use drinking faucets

Standard Finishes

AG1800/BRN	Brushed Nickel	\$ 152
AG1800/CHBRZ	Champagne Bronze	\$ 221
AG1800/CPB	Polished Chrome	\$ 144
AG1800/MB	Matte Black	\$ 184
AG1800/ORB	Oil Rubbed Bronze	\$ 162
AG1800/PN	Polished Nickel	\$ 152
AG1800/ULB	Unlacquered Brass	\$ 144
AG1800/VB	Venetian Bronze	\$ 162

Group 1 Finishes

All Group 1 Finishes **\$ 184**

Group 2 Finishes

All Group 2 Finishes **\$ 221**



Faucet Air Gap Unit for MT1853-NL & MT1873-NL

AG1850

A reverse osmosis air gap usually required by the filter manufacturer and plumbing codes for installing select faucets.

- Requires two mounting holes
- For use with Little Gourmet® point of use drinking faucets

Standard Finishes

AG1850/BRN	Brushed Nickel	\$ 152
AG1850/CHBRZ	Champagne Bronze	\$ 221
AG1850/CPB	Polished Chrome	\$ 144
AG1850/MB	Matte Black	\$ 184
AG1850/ORB	Oil Rubbed Bronze	\$ 162
AG1850/PN	Polished Nickel	\$ 152
AG1850/ULB	Unlacquered Brass	\$ 144
AG1850/VB	Venetian Bronze	\$ 162

Group 1 Finishes

All Group 1 Finishes **\$ 184**

Group 2 Finishes

All Group 2 Finishes **\$ 221**

Hot Side Replacement Cartridge for Francis Anthony Collection Accessory Faucets



DHM32324

\$ 44

Hot side replacement cartridge used for the following faucets:

- MT1800-NL, MT1801-NL
- MT1820-NL, MT1821-NL
- MT1830-NL, MT1831-NL
- MT1840-NL, MT1841-NL
- MT1850-NL, MT1851-NL
- MT1870-NL, MT1871-NL
- MT1880-NL, MT1881-NL

Cold Side Replacement Cartridge for Francis Anthony Collection Accessory Faucets



DHM32325

\$ 44

Cold side replacement cartridge used for the following faucets:

- MT1803-NL, MT1801-NL
- MT1823-NL, MT1821-NL
- MT1833-NL, MT1831-NL
- MT1843-NL, MT1841-NL
- MT1853-NL, MT1851-NL
- MT1873-NL, MT1871-NL
- MT1883-NL, MT1881-NL



Threaded Shank Adaptor for Thicker Countertop Installations

MT600/ADPT

All Point of Use Faucets will fit 2 1/4" thick deck. Adaptor will lengthen this shank by 2 3/4"

- Price.... **\$ 18**